

# MOBILIERS EXTÉRIEURS OUTDOOR FURNITURE

STRATIFIÉ COMPACT HPL - COMPACT HPL

 polyrey®

OUVREZ LES PERSPECTIVES  
sur vos aménagements extérieurs

OPEN THE POTENTIAL  
of your outdoor fittings

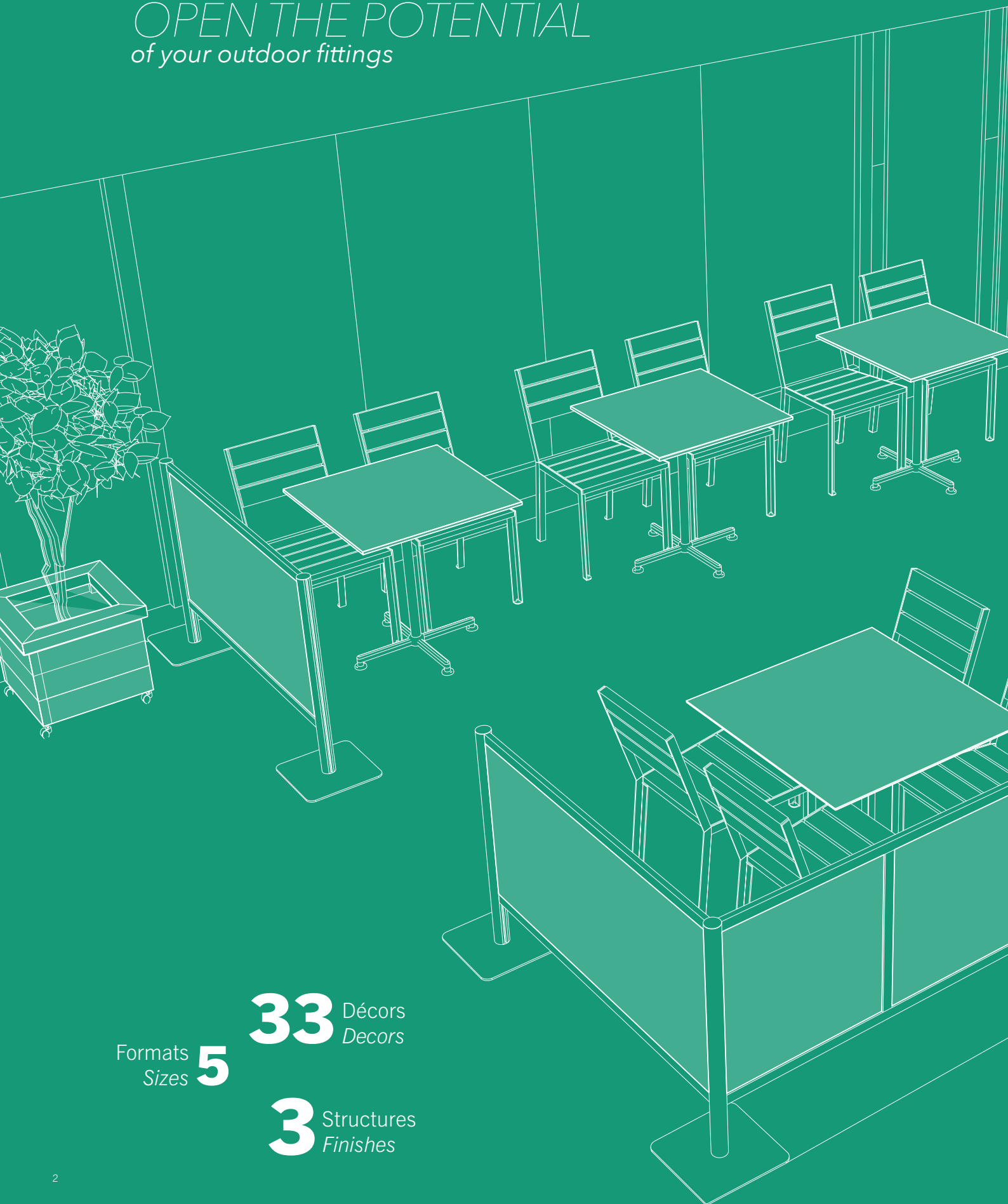

Formats  
Sizes **5**

**33** Décors  
Decors

**3** Structures  
Finishes

STRATIFIÉ COMPACT HPL

## REYSIPUR®

COMPACT HIGH PRESSURE LAMINATE

## Matière dense et polyvalente

Avec Reysipur®, produit résistant, imputrescible et design, Polyrey vous accompagne depuis la mise en oeuvre jusqu'à l'usage quotidien de vos mobiliers extérieurs. Polyrey a sélectionné des décors de Stratifiés Compact HPL Reysipur® parfaitement adaptés aux conditions extérieures pour permettre l'agencement d'espaces de vie tels que les terrasses, parcs et jardins, aires de repos...

## Dense &amp; multi-purpose material

Polyrey accompanies you from the application to the daily use of your outdoor furniture thanks to Reysipur®, a resistant, rot-proof and decorative product. Polyrey has selected a range of decors among the Reysipur® Compact HPL range adapted to outdoor conditions that can be used for creating living spaces such as terraces, parks and gardens, rest areas, etc.



Faible vieillissement aux UV\*  
Low UV-ageing\*



Imputrescible  
Rotproof



Résiste aux intempéries  
Weather resistant



Résiste au gel  
Frost resistant



Résiste à l'abrasion  
Abrasion resistant



Apte au contact alimentaire  
Suitable for food contact



Nettoyage facile  
Easy to clean



Anti-moisissures / champignons  
Anti mold / fungus

Retrouvez nos Conseils d'Expert en pages 8 et 9

See our Expert's Advice on pages 8 and 9.



## Sanitized®

Tous les produits Polyrey font l'objet d'un traitement antibactérien Sanitized® permettant de ralentir la prolifération de 99,9% des bactéries\*\*.

All Polyrey products receive a Sanitized® antibacterial treatment that reduces the growth of 99,9% bacteria\*\*.

\* Résistance de surface au vieillissement accéléré selon la norme EN 438-2-29, échelle des gris ≥ 3 à 1500 h.  
Surface resistance to accelerated ageing according to the EN 438-2-29 standard, grey scale ≥ 3 to 1500h.

\*\* Le traitement Sanitized contient un produit biocide avec substance active : le verre de phosphate. Cette substance n'est pas concernée par les restrictions REACH, car nous veillons à ce que nos fournisseurs n'utilisent aucune substance dangereuse.  
The Sanitized® treatment contains a biocidal product with active substance: silver phosphate glass. This substance is not covered by the REACH restrictions as we ensure our suppliers do not use any harmful substances.

# UN PRODUIT, DES APPLICATIONS ONE PRODUCT, MANY APPLICATIONS

Un produit adapté au **meublier extérieur**

## Tables

Table bistrot  
*Bistro table*

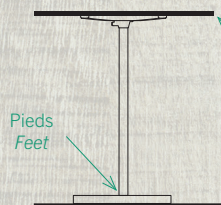

Plateau de table  
*Table top*

Table bistrot à plateau basculant  
*Bistro table with tilting top*

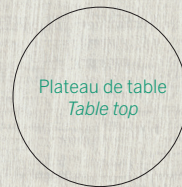
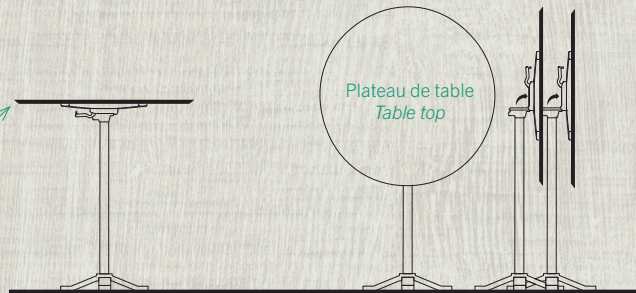

## Autres mobiliers

Table de pique-nique  
*Picnic table*

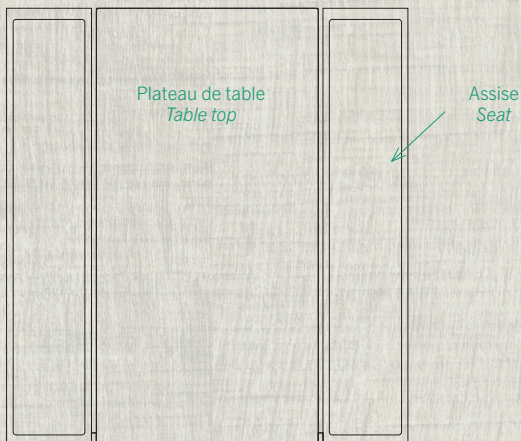
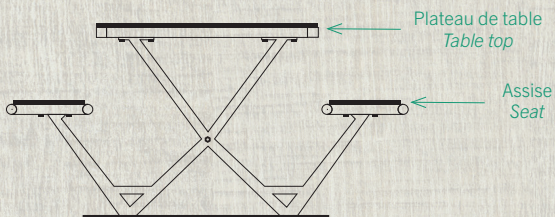

Portillon  
*Gate*



Barrière / Paravent  
*Fence / Screen*

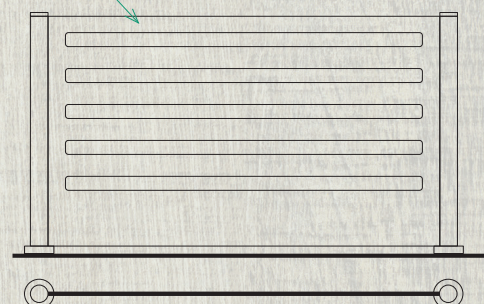

A product suitable for outdoor furniture

Tables

Grande table  
Large table

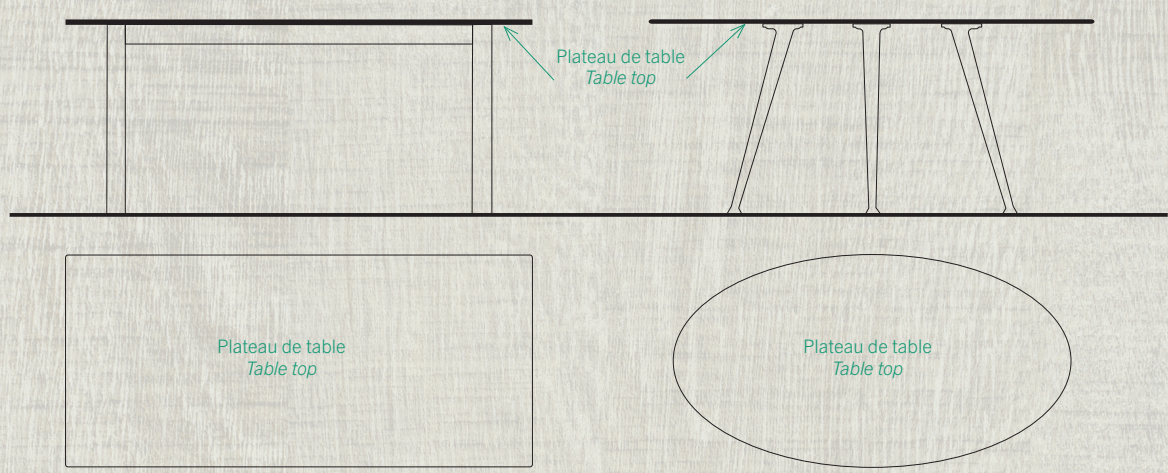

Other furniture

Banc  
Bench

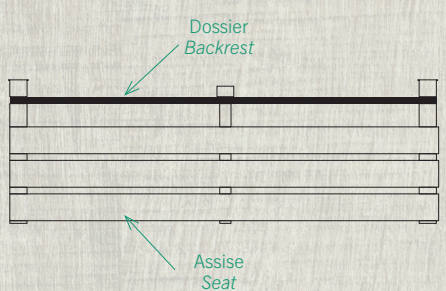
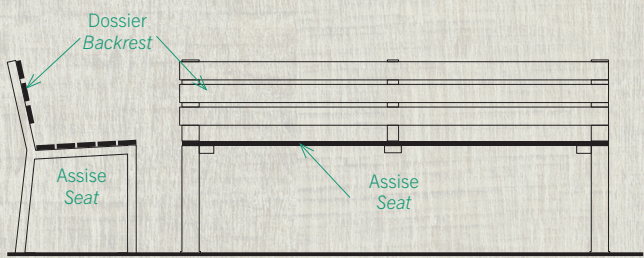

Corbeille  
Basket

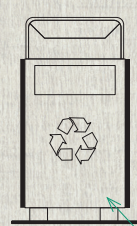

Jardinière  
Planter

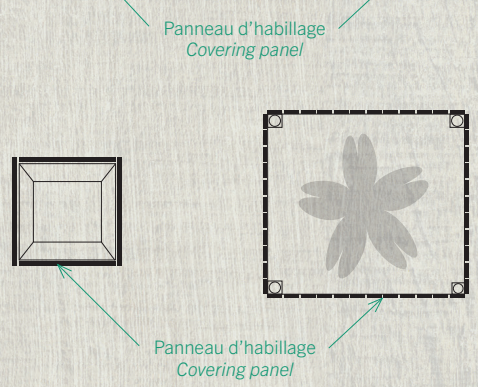
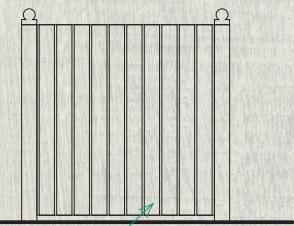

# 5 FORMATS, LES SOLUTIONS POLYREY

## 5 SIZES, POLYREY SOLUTIONS

### FA (satin)

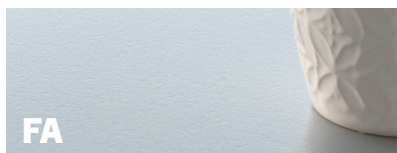

FA

FA est une finition satin léger au grain ultra fin.  
FA is a light satin finish with an extra fine grain.

#### Tables bistrot - *Bistro table*

Les formats de panneaux en structure FA vous permettent de réaliser l'ensemble de vos mobiliers extérieurs dont les tables carrées ou rondes type bistrot.

Vous pouvez réaliser vos tables rondes de diamètre 60 cm, 70 cm et 80 cm dans ces mêmes formats de panneaux.

*The panel sizes in the FA finish allow you to create all types of outdoor furniture, including square or round bistro-style tables.*

*You can make 60 cm, 70 cm and 80 cm diameter round tables using these same panel sizes.*

307 × 124 cm

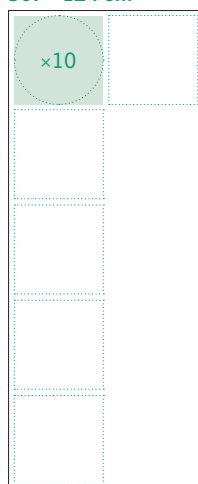

60 × 60 cm • Ø 60 cm



366 × 151 cm

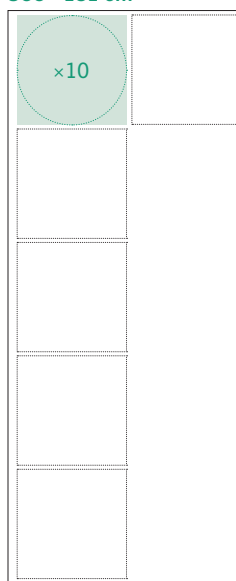

70 × 70 cm • Ø 70 cm



432 × 166 cm

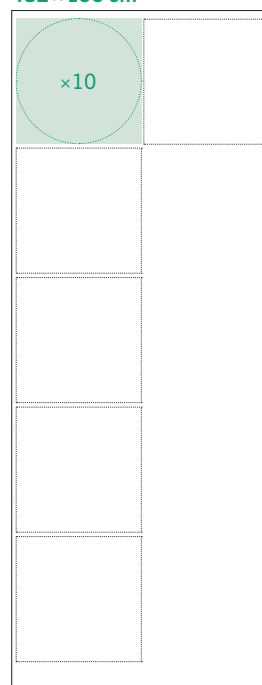

80 × 80 cm • Ø 80 cm



### ROCHE - LINIMAT

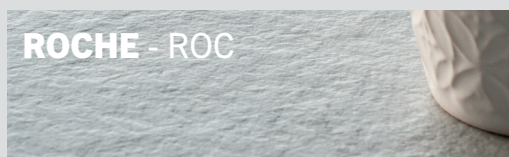

ROCHE - ROC

ROCHE offre un aspect minéral bosselé aux évocations de pierre naturelle.

*ROCHE offers a dented mineral aspect resembling natural stone.*



LINIMAT - LIM

LINIMAT est une structure lignée et mate apportant du caractère aux différentes essences de bois.

*LINIMAT is a matt, linear finish that gives character to the different wood species.*

#### Tables bistrot premium - *Square premium tables*

Les tables bistrots sont sublimes par des structures profondes pour un rendu haut de gamme.

*The bistro tables are enhanced by the deep finishes for a high-end rendering.*

307 × 132 cm

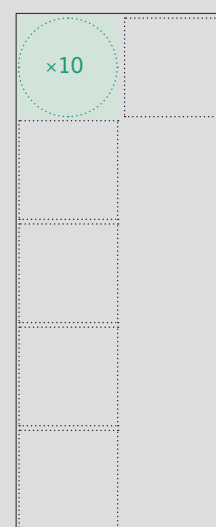

60 × 60 cm • Ø 60 cm



## FA (satin)

### Autres tables - Other tables

Pour la réalisation de plateaux rectangulaires ou ovales, les panneaux en structure FA offrent de multiples possibilités pour la réalisation de tables de jardin, tables de pique-nique ou encore tables basses.

*For creating rectangular or oval table tops, the panels in the FA finish offer many possibilities for garden tables, picnic tables or coffee tables.*

215 x 97 cm

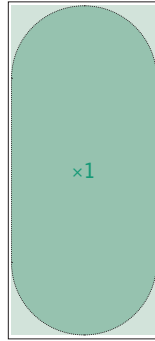

210 x 95 cm



307 x 124 cm

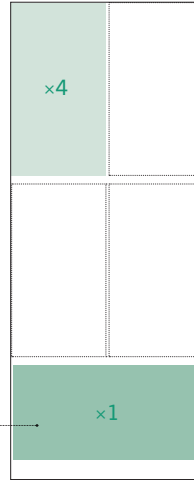

4 tables : 110 x 60 cm



1 table : 120 x 80 cm



432 x 166 cm

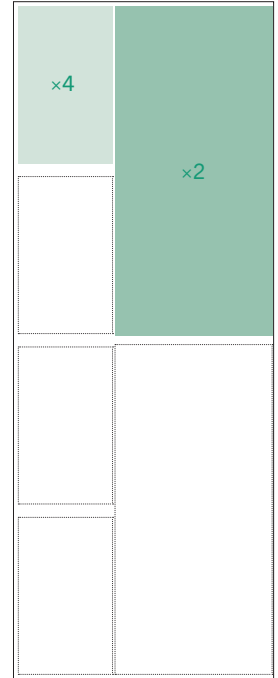

4 tables : 100 x 60 cm

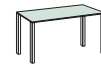

2 tables : 210 x 100 cm

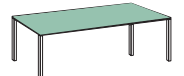

Pour les décors bois, l'orientation de la découpe des plateaux de table détermine le sens du fil horizontal ou vertical.

*For wood decors, the direction of the table top cut-out determines the direction of the horizontal or vertical grain.*

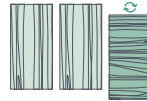

### Autres tables premium - Other premium tables

Donnez du cachet à vos mobiliers en plus grand format grâce aux structures Premier.

*Give your furniture more style in larger sizes with Premier finishes.*

307 x 132 cm

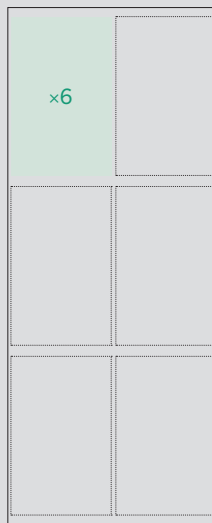

6 tables : 100 x 65 cm



307 x 132 cm



2 tables : 130 x 130 cm

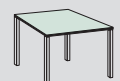

4 tabourets : 40 x 30 cm  
4 stools



# CONSEILS D'EXPERT EXPERT'S ADVICE

## Des surfaces pour s'exprimer

## Surfaces to express yourself

### Préparation avant mise en œuvre

Stockez les panneaux dans un local, à plat sur une surface rigide, plane et à l'abri de l'humidité dessus-dessous, pour éviter des déformations irréversibles avant mise en œuvre.

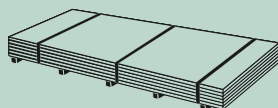

### Découpe

Découpez des formes rondes, carrées ou rectangulaires, pleines ou ajourées pour vos tables et mobiliers. La réalisation des ajourages doit se faire avec des angles intérieurs arrondis, pour éviter le risque de fissuration.

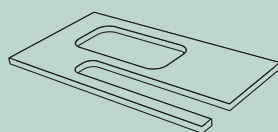

### Usinage des chants

Faites la différence sur votre mobilier extérieur avec des chants chanfreinés, arrondis ou en ailes d'avion. Un angle à 45° sous la face favorisera l'écoulement de l'eau et limitera l'exposition au soleil des chants pour une durée de vie prolongée de vos réalisations.



### Rainurage et gravure

Personnalisez vos surfaces verticales par le rainurage ou la gravure afin de créer signalétique ou personnalisation. Grâce au noyau noir, le résultat est sobre et épuré. Un traitement de protection du noyau est recommandé. Il est préférable de ne pas graver des surfaces horizontales pour éviter la stagnation d'eau.

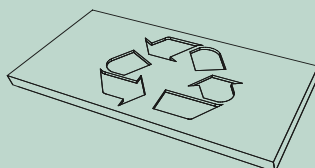

### Fixation

Fixez facilement vos éléments avec une visserie adaptée, type vis métallique non auto-foreuse A2 avec pré-perçage. Pour des fixations sollicitées, il est préconisé d'utiliser des inserts. Suivant les domaines d'emploi et le type d'usage, privilégiez des fixations traversantes boulonnées.

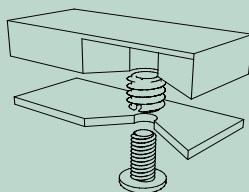

### Cadre et renforts

Anticipez les renforts suivant les utilisations, de préférence de forme tubulaire en qualité aluminium ou métallique, avec traitement de protection laqué. Entraxe maximum conseillé :

- Pour le 10 mm : 400 mm
- Pour le 12,5 mm : 450 mm

Porte-à-faux maximum réalisable :

- Pour le 10 mm : 50 mm
- Pour le 12,5 mm : 75 mm

La fixation du panneau doit tenir compte des variations dimensionnelles.

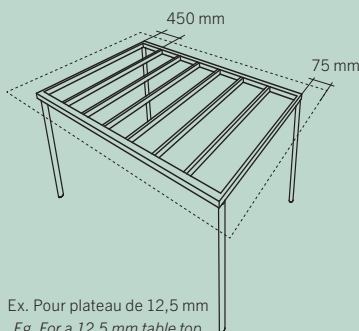

### Préparation before application

Store the panels indoors, laid on a rigid, flat surface that is moisture-proof both on top and underneath, to avoid irreversible deformation before installation.

### Cuts

Cut round, square or rectangular, solid or openwork shapes for your tables and furniture. Openwork shapes must be made with rounded inner corners to avoid the risk of cracking.

### Edge machining

Make your outdoor furniture stand out with chamfered, rounded or airplane wing-style edges. A 45° angle under the face will help water flow and limit the exposure of the edges to the sun for an extended life of your creations.

### Grooves and engraving

Customize your vertical surfaces with grooves or engraving to create signage or personalization. The black core gives a more sober, pure result. We recommend using a treatment to protect the core. We do not recommend engraving horizontal surfaces to avoid water stagnation.

### Fixing

Fix your elements easily with an adapted screw, such as a non-self-drilling A2 metal screw with pilot drilling. For high-use fixings we recommend using inserts. Depending on the area of application and type of use, bolted through fasteners are preferable.

### Frame and reinforcements

Anticipate the reinforcements according to the use, preferably tubular, made from aluminium or metal, with protective lacquer.

Maximum recommended centre distance:

- For 10 mm : 400 mm
- For 12,5 mm : 450 mm

Maximum overhang:

- For 10 mm : 50 mm
- For 12,5 mm : 75 mm

The panel must be fixed taking dimensional variations into account.

Pour plus d'informations, contactez-nous. - For further information, please contact us.



## Des surfaces pour durer

## Surfaces made to last

### Les bons gestes pour un mobilier durable

#### Choix des décors

Au fil des années, la pluie, les variations de température, les salissures organiques et la pollution engendrent une légère décoloration naturelle des décors. Les performances mécaniques du matériau ne sont pas altérées par cette évolution colorielle et votre mobilier reste tout aussi résistant.

Les décors clairs et moins pigmentés présentent par nature une meilleure durabilité des couleurs.

À l'inverse, les dégradations visuelles sont davantage perceptibles sur les décors foncés.

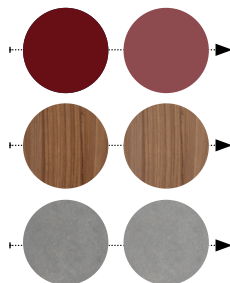

### The right approach for durable furniture

#### Choice of decors

Over the years, rain, temperature variations, organic matter and pollution cause a slight natural discoloration of decors. The mechanical performance of the material is not altered by this colour change and your furniture remains just as resistant.

Lighter and less pigmented decors have by nature a better colour durability.

On the other hand, dark decors will be more difficult to maintain, as the visual degradations are more noticeable.

#### Entretien

Votre mobilier extérieur est facile à entretenir quotidiennement avec un chiffon humide et un nettoyant dégraissant neutre. Pour un aspect optimal, nous préconisons de rincer et de sécher la surface. Pour garantir la longévité de vos surfaces, nous vous recommandons de procéder à un nettoyage immédiat de tout produit tâchant avec un nettoyant adapté.

Pour du nettoyage ponctuel ou de remise en service après hivernage, il est possible d'éliminer les dépôts incrustés (mousse, pollution...) avec un nettoyeur haute pression.

Les surfaces ne requièrent aucun traitement supplémentaire. Pour éviter l'oxydation naturelle du noyau et assurer une parfaite finition, il est néanmoins possible d'appliquer un vernis imperméabilisant ou de l'huile de lin. En cas de taches résiduelles, vous pouvez rénover le noyau par égrainage.



#### Care

Your outdoor furniture is easy to maintain on a daily basis with a damp cloth and a neutral degreasing cleaner. For an optimal aspect, we recommend rinsing and drying the surface. To guarantee the longevity of your surfaces, we recommend that you clean stains with a suitable cleaner immediately.

For occasional cleaning or re-use after winter storage, it is possible to remove encrusted deposits (moss, pollution, etc.) with a high-pressure cleaner.

The surfaces do not require any additional treatment. To avoid natural oxidation of the core and to ensure a perfect finish, it is nevertheless possible to apply a waterproof varnish or linseed oil. For residual stains, you can renovate the core by sanding.

#### Protection du mobilier

Pour prolonger sa durée de vie, il est recommandé de stocker le mobilier à l'abri ou de le protéger (avec une housse de protection respirante), en particulier pendant les longues périodes de non-utilisation. Un mobilier fixe et non protégé vieillira plus vite.

Il est déconseillé de laisser de l'eau stagnante de manière prolongée sur la surface du produit. Des solutions existent, telles qu'un système de plateau à pivot pour les tables mobiles, une légère inclinaison des surfaces ou un ajourage des panneaux pour le mobilier fixe.

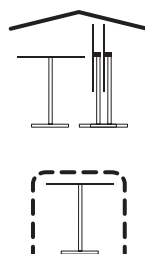

#### Protection of furniture

To extend the lifespan of furniture, it should be stored under cover or protected (with a breathable protective cover), especially during long periods of non-use. Fixed, unprotected furniture will age more quickly.

It is not advisable to leave stagnant water on the product surface for prolonged periods of time. Solutions are available, such as a flip-top table top system for mobile tables, a slight inclination of surfaces or a panel cut-out for fixed furniture.

Les motifs énoncés ci-après ne peuvent faire l'objet de réclamation:

- L'usure et le vieillissement naturel des produits Polyrey, dont la décoloration
- L'utilisation de produits abrasifs, d'entretien ou de nettoyage inadaptés
- Le non-respect des précautions, conseils et instructions en matière d'utilisation, de montage, d'entretien, de stockage, ou de protection des produits

The reasons outlined below will not be accepted as the subject of a complaint:

- Natural ageing and wear and tear of Polyrey products, including discoloration
- The use of unsuitable abrasive maintenance or cleaning products
- Failure to comply with the precautions, advice and instructions regarding the use, assembly, maintenance, storage or protection of the products

STRATIFIÉ COMPACT HPL

# REYSIPUR®

COMPACT HIGH PRESSURE LAMINATE

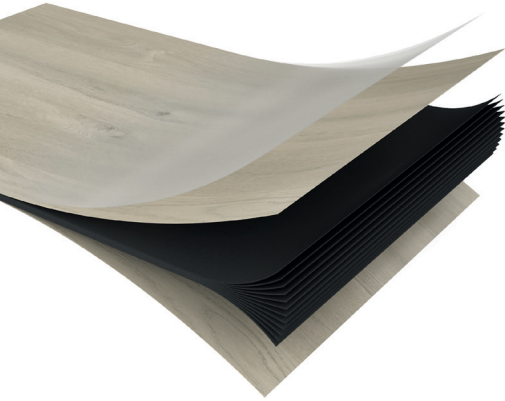

## Adapté aux environnements extérieurs Suited for outdoor areas

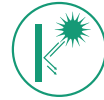

Faible vieillissement aux UV\*  
Low UV-ageing\*



Imputrescible  
Rotproof



Résiste aux intempéries\*\*  
Weather resistant\*\*



Résiste au gel  
Frost resistant

## Hygiène - Hygienic



Antibactérien  
Antibacterial



Apte au contact alimentaire  
Suitable for food contact



Nettoyage facile  
Easy to clean



Anti-moisissures / champignons  
Anti mold / fungus

## Résistance - Resistant to



Abrasion  
Abrasion



Rayures  
Scratches



Chaleur jusqu'à 180 °C  
Heat up to 180 °C



Brûlure de cigarette  
Cigarette burn

\* Résistance de surface au vieillissement accéléré selon la norme EN 438-2-29, échelle des gris ≥ 3 à 1500 h.  
Surface resistance to accelerated ageing according to the EN 438-2-29 standard, grey scale ≥ 3

\*\* Test en chambre climatique sur 2 cycles de 21 jours alternant 7 jours à 50°C / 95% HR ; 7 jours à -10°C (gel) ; 7 jours à 50°C / 20% HR  
Tested in a climatic chamber on 2 cycles of 21 days alternating 7 days at 50°C / 95% RH; 7 days at -10°C (frost); 7 days at 50°C / 20% RH

## Matière dense & polyvalente

Panneau stratifié épais  
2 faces décoratives

- Adapté aux environnements fortement sollicités, y compris en extérieur
- Nettoyage rapide et facile (surface non poreuse non propice au développement de champignons et moisissures)
- Des performances supérieures au bois : propriétés mécaniques, entretien...

- Convient pour des applications horizontales et verticales
- Rapidité de pose
- Autoportant
- Panneau difficilement inflammable (qualité ignifuge sur demande)
- Ne nécessite pas de traitement de surface et des chants

## Dense & multi-purpose material

Thick laminate panel  
decorative on both sides

- Ideal for use in heavy-duty environments, including outdoors
- Quick and easy to clean (non-porous surface resistant to fungus and mould growth)
- Enhanced performances compared to wood : mechanical properties, care...

- Suitable for horizontal and vertical applications
- Easy installation
- Self-supporting
- Flame-retardant panel (fire-retardant quality on request)
- Do not require surface or edge treatment

Certificats & fiches techniques disponibles sur [www.polyrey.com](http://www.polyrey.com)

Certificates & technical data are available at [www.polyrey.com](http://www.polyrey.com)

### Formats & épaisseurs

**FORMATS :** 215 × 97 cm  
307 × 124 cm • 307 × 132 cm  
366 × 151 cm • 432 × 166 cm

**ÉPAISSEURS :** 10 mm • 12,5 mm  
Autres épaisseurs sur demande

### Sizes & thicknesses

**SIZES:** 215 × 97 cm  
307 × 124 cm • 307 × 132 cm  
366 × 151 cm • 432 × 166 cm

**THICKNESSES :** 10 mm • 12,5 mm  
Other thicknesses upon request

### Labels

### Labels



# SEGMENTS SECTORS

Un produit adapté à  
**tous types de projets**

Café-Restaurant, Loisirs,  
Aménagement urbain, Résidentiel

*Product suitable for  
**all types of projects***

*Cafés - Food service, Leisure,  
Urban development, Residential*

CAFÉ  
RESTAURATION

CAFÉS  
FOOD SERVICE

---



LOISIRS

LEISURE

---



AMÉNAGEMENT  
URBAIN

URBAN  
DEVELOPMENT

---



RESIDENTIEL

RESIDENTIAL

---



# CAFÉ RESTAURATION CAFÉS - FOOD SERVICE



## ENTRETIEN FACILE

Reysipur® est facile à nettoyer et offre des propriétés antibactériennes Sanitized® qui permettent le ralentissement de la prolifération des bactéries.

## EASY TO MAINTAIN

Reysipur® is easy to clean and offers Sanitized® antibacterial properties that reduce the growth of bacteria.



T107  
Terrazzo Cassala

C190  
Céladon



C148 - LINIMAT  
Chêne Pyla



B116  
Beige Nature

B134  
Béton Griffé



### COMPLÉMENTARITÉ

La sélection décorative Mobiliers Extérieurs peut s'étendre aux aménagements intérieurs. Ouvrez les perspectives !

### COMPLEMENTARITY

The decorative selection of Outdoor Furniture can also be extended to interior fittings. Broaden your horizons!



P001  
Pierre de Lune

M124  
Marbre Taisa



C187  
Cerisier Ambré



# RESIDENTIEL RESIDENTIAL



## DESIGN

Avec une palette étendue de designs unis, bois ou matières, les possibilités sont multiples. Les 2 structures PREMIER, ROCHE au relief minéral ou LINIMAT aux lignes de bois pleines de caractère, apportent un aspect résolument premium.

## DESIGN

*With a wide range of plain, wood or material designs, the possibilities are numerous. The two PREMIER finishes, ROCHE with a mineral relief or LINIMAT with characterful wood lines, provide a resolutely premium aspect.*



# LOISIRS LEISURE

**+  
RÉSISTANT  
& IMPUTRESCIBLE**

Reysipur® permet la réalisation d'agencements urbains résistants aux intempéries et au gel.

**RESISTANT  
& ROTPROOF**

Reysipur® allows you to create urban layouts that are weather and frost-resistant.



**B193**  
Bouleau de Gaspésie

**X193**  
Noir



**C187**  
Cerisier Ambré

## AMÉNAGEMENT URBAIN URBAN DEVELOPMENT

# STRUCTURES FINISHES



Une structure incontournable pour des projets tout en simplicité et en sobriété.

*An essential finish for simple, understated projects.*

## **FA**

Finition satin léger au grain ultra fin et au toucher doux, qui séduit par sa pureté et sa discrétion.

*Light satin finish with an extra fine grain and soft texture with charming purity and discretion.*



Deux structures ultra design pour un rendu haut de gamme.  
*Two ultra-design finishes for a very high-end rendering.*

## **ROCHE - ROC**

Relief bosselé aux évocations de pierre naturelle ou de métal martelé, sublimé par un aspect mat qui lui donne toute sa profondeur.

*An uneven texture with hints of natural stone or hammered metal combined with a matt finish that creates a surprising depth.*

## **LINIMAT - LIM**

Une structure lignée et mate apportant du caractère et de la contemporanéité aux différentes essences de bois.

*A lined and matt finish that adds character and a contemporary feel to the different varieties of wood.*





# NUANCIER

# COLOUR CHART

## 33 Décors disponibles en Stratifié Compact HPL Reysipur® Decors available in Reysipur® Compact HPL



**B117** FA - ROCHE  
*Blanc Arctique*



**G044** FA  
*Gris Dauphin*



**G075** FA - ROCHE  
*Gris Cendré*

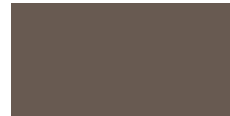

**F006** FA - ROCHE  
*Fer*



**P114** FA  
*Poivre*



**B070** FA - ROCHE  
*Blanc Megève*



**C017** FA  
*Coquille d'Œuf*



**B116** FA  
*Beige Nature*



**P001** FA  
*Pierre de Lune*



**B127** FA  
*Brun Havane*

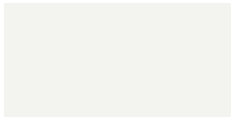

**B015** FA  
*Blanc Menuires*

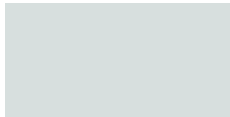

**F008** FA  
*Fumée*



**C190** FA  
*Céladon*



**M102** FA  
*Miel Sucré*



**R057** FA  
*Rouge Amarante*



**C128** FA - LINIMAT  
*Chêne Alaska*



**B193** FA - LINIMAT  
*Bouleau de Gaspésie*



**C183** FA - LINIMAT  
*Chêne d'Argent*



**F056** FA - LINIMAT  
*Frêne Scandinave*



**B100** FA  
*Banian Blanchi*



**C180** FA - LINIMAT  
*Chêne Alba*



**C148** FA - LINIMAT  
*Chêne Pyla*

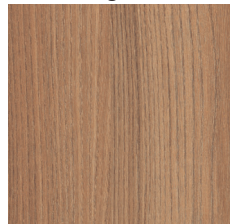

**O079** FA - LINIMAT  
*Orme Armagnac*

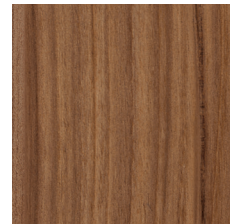

**C187** FA - LINIMAT  
*Cerisier Ambré*



**C149** LINIMAT  
*Chêne Colorado*



**A120** FA  
*Aracena*

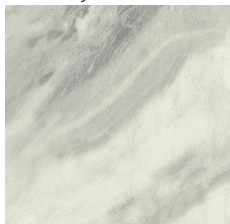

**M134** FA  
*Marbre Siroco*

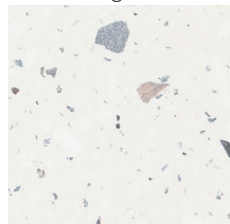

**T107** FA  
*Terrazzo Cassata*

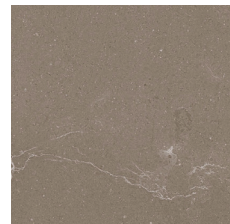

**M124** FA  
*Marbre Taisa*

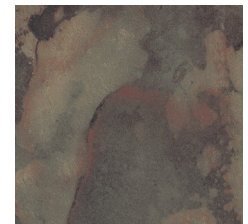

**A095** FA - ROCHE  
*Ardoise Oxydée*



**B134** FA - ROCHE  
*Béton Griffé*



**T006** FA - ROCHE  
*Tectonica*

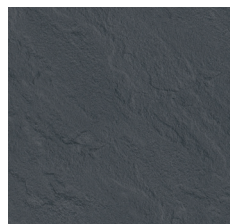

**S049** FA-ROCHE  
*Slate*

Les visuels des pleins panneaux sont disponibles sur [www.polyrey.com](http://www.polyrey.com)

Full-sheet views are available at [www.polyrey.com](http://www.polyrey.com)



La reproduction imprimée des décors peut différer du produit réel, n'hésitez pas à demander un échantillon pour finaliser votre choix.  
The printed reproduction of the decorations may differ from the actual product, do not hesitate to request a sample to finalize your choice.

Disponible en structure Premier  
Available in Premier finish

# TABLEAU DE DISPONIBILITÉ

# AVAILABILITY TABLE

		REYSIPUR® Stratifié Compact HPL - Compact HPL								
QUALITY - GRADE		FORMAT SIZE	215 × 97 cm	307 × 124 cm	307 × 132 cm	366 × 151 cm	432 × 166 cm	STRUCTURES - FINISHES		
	Standard - Standard CGS : Euroclasse C-s1,d0	NOYAU / SUPPORT CORE / SUBSTRATE	Noyau kraft Noir - Black Phenolic Core					FA FA (Satin)		
	Ignifuge - Fire retardant CGF : Euroclasse B-s1,d0	ÉPAISSEUR THICKNESS	4 - 6 - 8 - 10 - 12,5 mm			4 - 6 - 8 - 10 - 12,5 mm				
			4 - 6 - 8 - 10 - 12,5 mm						ROC Roche LIM Linimat	
	Code Code	Décor Decor	Premier	Structures Finishes				PANTONE	RAL	
UNIS COLOURS	030	Blanco Especial		FA	FA	FA	FA	9064 C	9016	
	B015	Blanc Menuires		FA	FA	FA	FA	9064 C	9016	
	B070	Blanc Megève		FA	FA	ROC	FA	9064 C	9016	
	B116	Beige Nature		FA	FA	FA	FA	9223 C	-	
	B117	Blanc Artic		FA	FA	ROC		9062 C	9003 (D)	
	B127	Brun Havane			FA			Black 7 C	8019 (D)	
	C017	Coquille d'Œuf		FA	FA	FA	FA	9180 C	1015 (D)	
	C190	Céladon			FA	FA	FA	5595 C	-	
	F006	Fer		FA	FA	ROC		405 C	7005 (L)	
	F008	Fumée			FA			536 C	-	
	G044	Gris Dauphin		FA	FA			413 C	7047	
	G075	Gris Cendré		FA	FA	ROC	FA	FA	415 C	7004
	M102	Miel Sucré			FA			7563 C	-	
	P001	Pierre de Lune		FA	FA	FA	FA	7531 C	7006 (D)	
P114	Poivre			FA			447 C	7021 (D)		
R057	Rouge Amarante			FA	FA	FA	FA	1817 C	3009	
BOIS WOODS	B100	Baniani Blanchi		FA	FA	FA	FA			
	B193	Bouleau de Gaspésie			FA	LIM				
	C128	Chêne Alaska			FA	LIM				
	C148	Chêne Pyla			FA	LIM				
	C149	Chêne Colorado		FA	FA	LIM	FA	FA		
	C180	Chêne Alba		FA	FA	LIM	FA	FA		
	C183	Chêne d'Argent			FA	LIM	FA	FA		
	C187	Cerisier Ambré			FA	LIM				
	F056	Frêne Scandinave		FA	FA	LIM				
	O079	Orme Armagnac			FA	LIM				
MATIERES MATERIALS	A095	Ardoise Oxydée			FA	ROC				
	A120	Aracena			FA	FA	FA			
	B134	Béton Griffé			FA	ROC				
	M124	Marbre Taisa			FA	FA	FA			
	M134	Marbre Siroco			FA	FA	FA			
	S049	Slate			FA	ROC				
	T006	Tectonica			FA	ROC				
	T107	Terrazzo Cassata			FA					

Pour faciliter la coordination de nos décors unis avec d'autres matériaux décoratifs, vous trouverez dans ce tableau les correspondances - RAL® - Pantone® de chaque décor. Les codes RAL® - Pantone® sont donnés à titre indicatif.

To facilitate co-ordination of our plain colour decors with other decorative materials, you will find the RAL® - Pantone® matches for each colour in this table. The RAL® - Pantone® codes are given on an indicative basis.

Ces décors ont subi un test de vieillissement accéléré selon la norme EN438-2-29 pour simuler l'ensoleillement et la pluie : le résultat est de niveau 3 sur l'échelle des gris à 1500h.

These decors have undergone an accelerated ageing test according to the EN438-2-29 standard to simulate sunshine and rain: the result is level 3 on the grey scale at 1500h.

# MY EXPERT

## Vous rendre service

À chaque étape de vos projets, Polyrey est à vos côtés pour en assurer la réussite et vous faire gagner du temps. Réputé pour son expertise produits, Polyrey s'engage aussi sur l'excellence de sa qualité de services.

## Here to help you

*Polyrey is at your side at every stage of your project to ensure its success and save you time. Known for its product expertise, Polyrey is also committed to quality of service.*

### 1 S'inspirer Find inspiration

Design Studio



Newsletter



Étude de cas  
Case studies



Structures 3D  
3D finishes



Visuels plein panneaux  
Full sheet views

### 2 Être conseillé Get advice



Documentation technique  
Technical documentation



Support technique  
Technical support



Conseil environnement  
Environmental advice



Formation  
Training



Équivalence décors  
Decor equivalence



Live Chat



Échantillons express  
Express Sample

100 %  
BIM



Descriptif type  
Product specification



Polyrey App

### 3 Choisir Choose



Livraison rapide  
Fast delivery



Distribution mondiale  
Global distribution



Trouver mon distributeur  
Find my distributor



Service Client 45 min  
45 min Customer Service

### 4 Acheter Purchase



### 5 Mettre en œuvre Apply



Conseils de mise en œuvre  
Usage advice



Assistance chantier  
Project assistance

POLYDAY



Visitez-nous  
Visit us



Partagez vos réalisations  
Share your creations

### 6 Partager Share

## La Charte de Service

Parce que votre métier exige de la réactivité et du professionnalisme, Polyrey s'engage :



24h

Expédier votre échantillon **le jour même**.  
Sending your sample **the same day**.



2h

Répondre à vos questions techniques **sous 2 h\***.  
Answering your technical questions **within 2 hrs\***.



45 min

Satisfaire vos demandes Service Client **sous 45 minutes\***.  
Responding to your Customer Service requests **within 45 minutes\***.

## The Service Charter

*Because your profession requires responsiveness and professionalism, Polyrey commits to :*

\* En cas de question particulière, ou s'il y avait une certaine complexité dans votre demande, nous nous engagerions sur un délai de réponse.  
\* If the question is unusual, or if your request presents a certain complexity, we will set a deadline on our response.

# MOBILIERS EXTÉRIEURS OUTDOOR FURNITURE

Échantillon  
Sample  
Muster  
Staal  
Muestra  
Amostra  
Campione

  
[www.polyrey.com](http://www.polyrey.com)



**FR** Tél. : +33 (0)5 53 73 56 89

**UK** Tél. : +44 (0)1923 202700

**DE** Tél. : +49 (0)211 90 17 40

**NL** Tél. : +31 (0)20708 31 31

**BE** Tél. : +32 (0)2 753 09 09

**ES** Tél. : +34 935 702 180

**PT** Tél. : +34 935 702 180

**IT** Tél. : +33 (0)5 53 73 56 87

**Export – Other countries** Tél. : +33 (0)5 53 73 56 88

 **polyrey**<sup>®</sup>

A WILSONART COMPANY

